

1A

REFLECTED PLAN VIEW

SCALE : 1/2" = 1'-0"

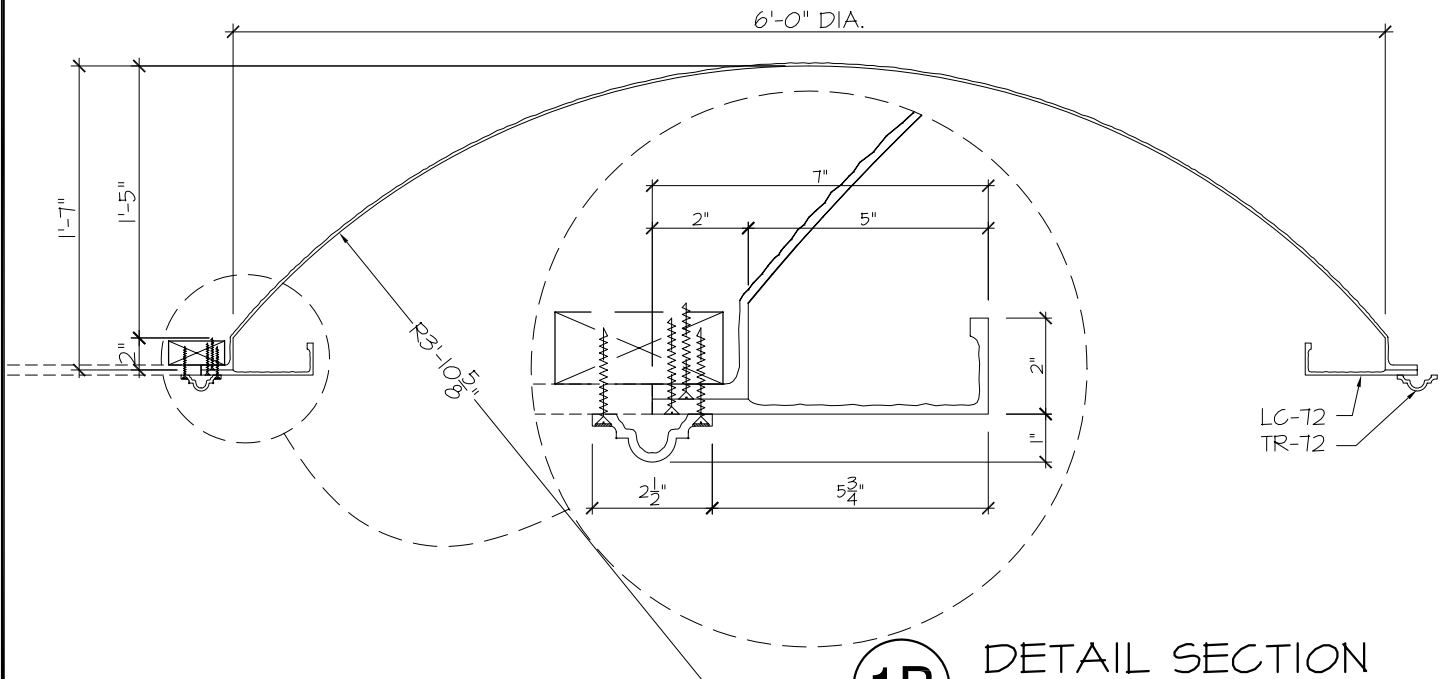

1B

DETAIL SECTION

SCALE : 1" = 1'-0"

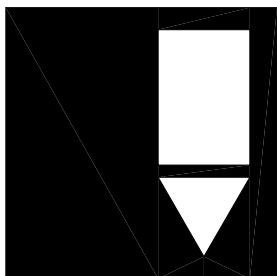

**FIRST CLASS
BUILDING
PRODUCTS**

3600 DALLAS HWY
SUITE #230-387
MARIETTA, GA 30064
Phone 770.514.8141
Fax 770.514.0731

PROJECT: FIRST CLASS		SHEET NO. D7219-LT
BUILDING PRODUCTS		
JOB NO:		PAGE OF
TITLE: GFRP DOME		
TITLE: 6'-0" DIAMETER		
SCALE: AS SHOWN	DRAWN BY: --	